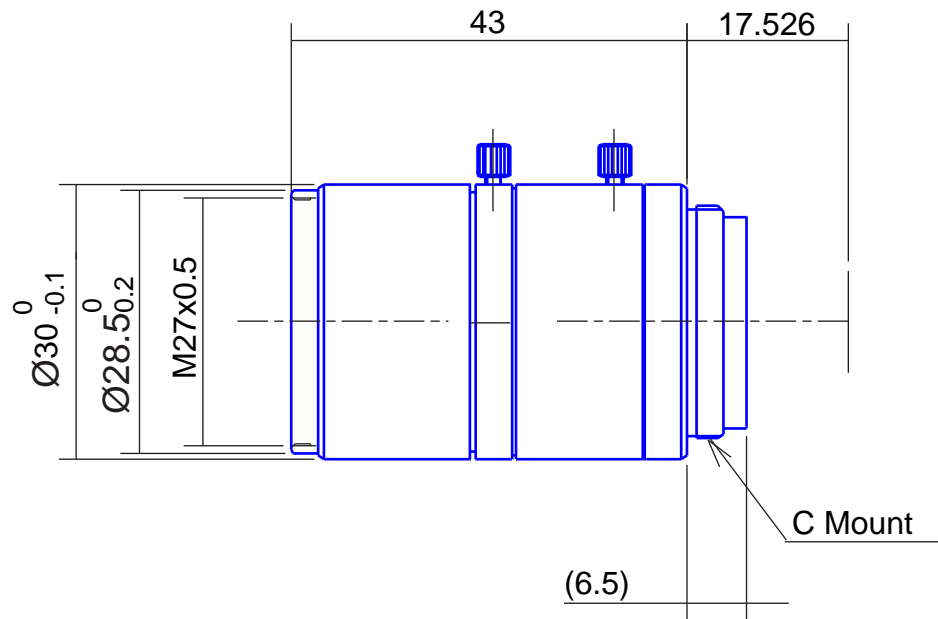

High Resolution Megapixel Lenses

Item No. GMTHR31614MCN

ITEM NO.		GMTHR31614MCN
Focal Length		16.2 (mm)
Iris Range		F1.45 - 16
Angle of View (H x V x D)	2/3"	30.46° x 23.07° x 37.55°
MOD		0.1 (m)
Filter Thread		M27.0, P=0.5
Dimension (D x L)		Ø30 x 42.5 (mm)
Weight		80 (g)
Notes		2megapixel